



Thanks to its structure composed by die-cast aluminum shells and high end materials, such as the worm gear and the bronze crown, the Athos motor range guarantees the maximum strength, reliability and lifespan.

Quick to be installed, Athos lets the maximum comfort, thanks to its high speed in opening and closing coupled to its silent operation.

The motor is irreversible; the emergency opening is always easy thanks to the triangular key locking system.

## DIMENSION (MM)

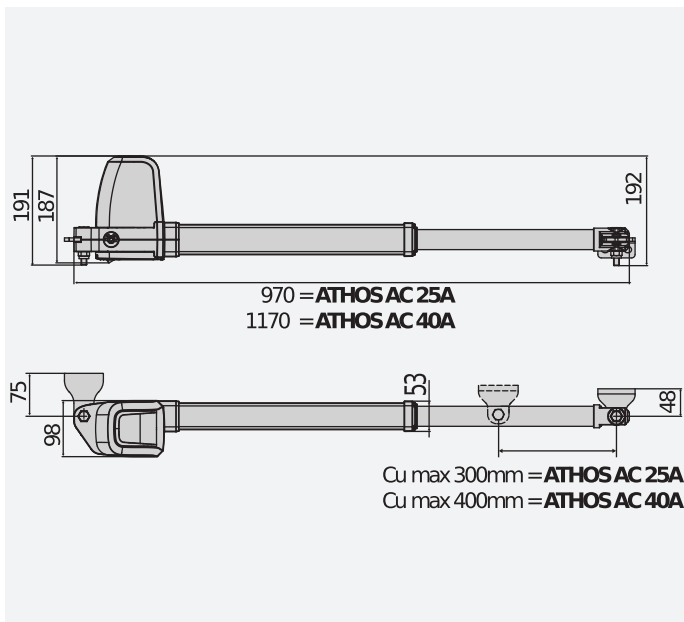

## INSTALLATION DIMENSIONS

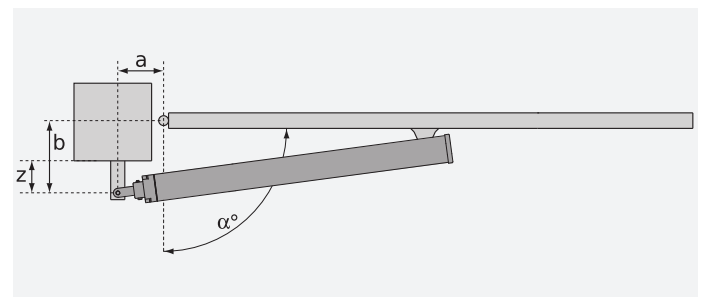

## TECHNICAL FEATURES

|                               | ATHOS AC A25 AR   | ATHOS AC A25 AL   | ATHOS AC A40 AR   | ATHOS AC A40 AL   |
|-------------------------------|-------------------|-------------------|-------------------|-------------------|
| Control unit                  | ALENA SW2         |                   |                   |                   |
| Board power supply            | 230 V             | 230 V             | 230 V             | 230 V             |
| Motor voltage                 | 230 V             | 230 V             | 230 V             | 230 V             |
| Power input                   | 280 W             | 280 W             | 280 W             | 280 W             |
| Max. width of door/gate wing  | 2.5 m             | 2.5 m             | 4 m               | 4 m               |
| Max. weight of door/gate wing | 700 kg            | 700 kg            | 400 kg            | 400 kg            |
| Useful rod stroke             | 300 mm            | 300 mm            | 400 mm            | 400 mm            |
| Maximum angle                 | 110 °             | 110 °             | 110 °             | 110 °             |
| Cycle time                    | 14 s              | 14 s              | 16 s              | 16 s              |
| Type of limit switch          | work time         | work time         | work time         | work time         |
| Slowdown                      | Yes               | Yes               | Yes               | Yes               |
| Locking                       | Mechanical        | Mechanical        | Mechanical        | Mechanical        |
| Release                       | Triangle key      | Triangle key      | Triangle key      | Triangle key      |
| Impact reaction               | Electronic clutch | Electronic clutch | Electronic clutch | Electronic clutch |
| Frequency of use              | Semi intensive    | Semi intensive    | Semi intensive    | Semi intensive    |
| Protection rating             | IP54              |                   |                   |                   |
| Environmental conditions      | -20 ÷ 55 °C       |                   |                   |                   |

|                  |                     |  | Description   |
|------------------|---------------------|--|---|
| P935108<br>00002 | ATHOS AC A25 AR     |  | Irreversible electromechanical operator 230 V for swing gates weighing up to 700 kg and 2.5 m long. |
| P935109<br>00002 | ATHOS AC A25 AL     |  | Irreversible electromechanical operator 230 V for swing gates weighing up to 700 kg and 2.5 m long. |
| P935115<br>00002 | ATHOS AC A40 AR     |  | Irreversible electromechanical operator 230 V for swing gates weighing up to 400 kg and 4 m long.   |
| P935116<br>00002 | ATHOS AC A40 AL     |  | Irreversible electromechanical operator 230 V for swing gates weighing up to 400 kg and 4 m long.   |
| R935339<br>00002 | ATHOS AC KIT A25 EU |  | Complete kit 230 V for swing gates up to 700 kg in weight and 2.5 m in length.                      |
| R935344<br>00002 | ATHOS AC KIT A40 EU |  | Complete kit 230 V for swing gates up to 400 kg in weight and 4 m in length.                        |

### ALENA SW2: Control panel with slow-down, dip switches and potentiometers for one or two 230V 400W+400W, operators for swing gates and industrial folding doors.

#### D113811 00004 - ALENA SW2 - Recommended















- Application: control panel for one or two operators for swing gates
- Board power supply: 230V single-phase
- Operators power supply: 230V single-phase 400W max each operator
- Caratteristiche principali: programmazione trimmer e dip-switch, morsettiere estraibili con colorazione standard, ricevente radio integrata, apertura pedonale da radiocomando
- Gestione rallentamenti in apertura e chiusura (solo sui motori elettromeccanici), gestione coste resistive 8K2/contatto, gestione dispositivi di sicurezza verificati, gestione elettroserratura, regolazione elettronica della coppia motore (solo su elettromeccanici), logica 3/4 passi, apertura pedonale, colpo di ariete in apertura.
- Main functions: stays locked when closed, 3/4 step logic, partial opening, fast closing and self-diagnostics
- Compatibility: ALTAIR and ARIES

## RECOMMENDED ACCESSORIES

|      |  |      |  |
|------|--|------|--|
| <br> | D113811 00004 - <b>ALENA SW2</b>   | <br> | N999724 - <b>PLE ATHOS</b>   |
|      | Control panel with slow-down, dip switches and potentiometers for one or two 230V 400W+400W, operators for swing gates and industrial folding doors. |      | Anchor plate for welding the mountings to masonry pillars for ATHOS operators. |
|      | D610180 - <b>CLS</b>   |      | N190104 - <b>BIR C</b>   |
|      | Triangular release key l=52 mm.  |      | Rubber safety edge (H 30 mm), price per m.                                     |
|      | P111401 00001 - <b>VENTIMIGLIA NS</b>  |      | D111013 - <b>ME</b>  |
|      | Infrared device for BIR C or BAR C safety edges (conforms to EN 12978 Standard).   |      | Control board for 12Vac solenoid lock for 230V automation systems.             |
|      | D121018 - <b>ECB VERTICALE</b>   |      | D113748 00002 - <b>RADIUS B LTA 230 R1</b>                                     |
|      | Vertical solenoid lock, 12/24 V.   |      | Flashing light with incorporated antenna for motors with power supply 230 V.   |



## RECOMMENDED ACCESSORIES

|   |   |   |   |
|---|---|---|---|
|    | <b>D113749 00002 - RADIUS B LTA 230 R2</b><br>Flashing light without incorporated antenna for motors with power supply 230 V. |    | <b>P123026 - B 00 R01</b><br>Metal guard for B LTA.   |
|    | <b>P123025 - B 00 R02</b><br>Wall mounting for B LTA series flashing beacons.   |    | <b>D111904 - MITTO B RCBO2 R1</b><br>Transmitter with 2 channels. Range 50/100 m. Power supply 12 V with 1 battery type 23 A. |
|    | <b>P121022 - Q.BO KEY WM</b><br>Key selector for outdoor use with double contact.   |    | <b>P121023 - Q.BO KEY WM AV</b><br>Vandalproof key selector with metal structure.   |
|    | <b>P121024 - Q.BO TOUCH</b><br>Wireless digital touch button panel 433 MHz rolling code.                                      |    | <b>P111526 - DESME A15</b><br>Pair of self-aligning photocells. Range 30 m. Power supply 24 V ac/dc.                          |
|   | <b>P903018 - PHP</b><br>Pair of aluminium posts for THEA/DESME series photocells Height 522 mm.                               |    | <b>P123001 00001 - EBP</b><br>230 V electric drop lock.   |
|  | <b>P123001 00013 - EBP 24</b><br>24 V solenoid lock, with 230/24 V transformer installable in control panel.                  |  | <b>P111052 - CM1700</b><br>Mechanical safety edge, length 1.7 m.  |
|   | <b>P111053 - CM2000</b><br>Mechanical safety edge, length 2 m.  |   |   |

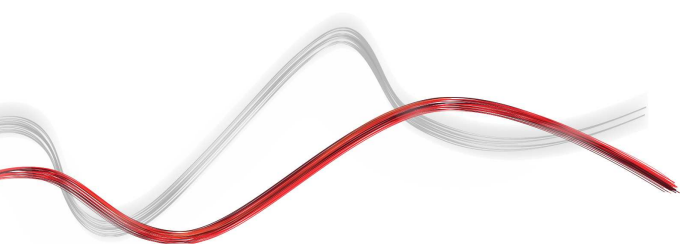

[www.bft-automation.com](http://www.bft-automation.com)

INFORMATIVA A TUTELA DEI DIRITTI DI PROPRIETA' INDUSTRIALE E INTELLETTUALE DI BFT. BFT S.p.A. tutela i propri diritti di proprietà industriale attraverso il deposito di marchi, brevetti, modelli e design. La proprietà intellettuale di BFT S.p.A. è tutelata a norma della legge sul diritto d'autore. BFT S.p.A. tutela inoltre il proprio know-how adottando misure di protezione delle informazioni tecniche e commerciali inerenti la propria azienda e i propri prodotti. Tutti i prodotti presenti in questo catalogo sono MODELLI ORIGINALI BFT e BFT S.p.A. è la sola autorizzata a produrli e commercializzarli in tutto il Mondo. Tutti i nomi commerciali attribuiti ai prodotti presenti in questo catalogo sono di titolarità di BFT S.p.A. che è la sola autorizzata al loro uso in relazione alla relativa categoria merceologica. I CONTRAFFATTORI VERRANNO PERSEGUITI A NORMA DI LEGGE SIA IN SEDE CIVILE CHE PENALE. IL TUTTO A GARANZIA NON SOLO DEL PATRIMONIO INTELLETTUALE DI BFT, MA ANCHE A TUTELA DEI CLIENTI CHE ACQUISTANDO PRODOTTI BFT ACQUISTANO PRODOTTI ORIGINALI FRUTTO DI STUDI E PROGETTI INTERNI ALLA SOCIETA' BFT.