

Range of automation for pedestrian doors swing, suitable for automating existing inputs and ideal for heavy use, heavy doors and large.

Available both with motorized control of opening and closing that with management of closure spring

DIMENSION (MM)

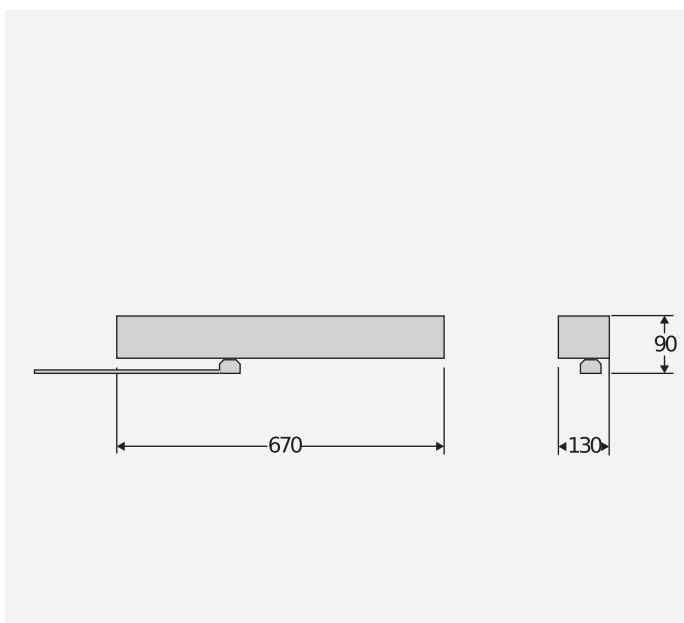















Technical features

	VISTA SW MXL-	VISTA SW SXL-
Control unit	Digital display and dip switch	Digital display and dip switch
Supply voltage AC	24 V	24 V
Nominal power consumption	400 W	400 W
Leaf type	Swing	Swing
Door weight	250 kg	250 kg
Maximum opening angle	110 °	110 °
Manual cycle	Reversible	Reversible
Motor type	Dunker motor	Dunker motor
Type of limit switch	Encoder	Encoder
Shaft max output torque	85 nm	85 nm
Closing	With motor	Return spring
Clear opening	700 ÷ 1400 mm	700 ÷ 1400 mm
Opening speed	up to 70	up to 70
Closing speed	up to 40	up to 40
Closing force (according to EN 1154)		EN4-EN6
Emergency operation	Backup Batteries	Spring closing/manual manoeuvre
Locking	Solenoid Lock	Solenoid Lock
Impact reaction	Electronic torque limiter	Electronic torque limiter
Use cycle	Continuous	Continuous
Protection rating	IP40	IP40





		Description
P960578 00002	VISTA SW MXL	Operator for hinged doors with motor opening and closing. Leaves with max. weight . max. width 684 mm. Ideal for "fail safe" installations (management with batteries).
P960577 00002	VISTA SW SXL	Operator for hinged doors with motor and closing with return spring. Leaves with max. weight . max. width 684 mm. Ideal for "fail secure" installations (management with spring).

VISTA SW

	D113789 - VISTA SEL SW Function selector Vista SW.		P111568 - TSWP XL Profiles Vista SW double, 1.5 m.
	P111564 - BBV SW MXL Emergency battery kit for Vista SW MXL, compatible with SXL with external installation.		P111563 00004 - EXT ASW XL 90 Arm connection L=90 mm Vista SW XL, spacer.
	P111563 00003 - EXT ASW XL 70 Arm connection L=70 mm Vista SW XL, spacer.		P111563 00002 - EXT ASW XL 50 Arm connection L=50 mm Vista SW XL, spacer.
	P111563 00001 - EXT ASW XL 30 Arm connection L=30 mm Vista SW XL, spacer.		P111567 - ASW XL ARTL Vista SW XL long articulated push arm. Jamb dimens. 150 mm.
	P111566 - ASW XL ART Vista SW XL articulated push arm. Max jamb dimens.: 150 mm.		P111565 - ASW XL RIG Vista SW XL rigid pull arm. Jamb max dimens.: 100 mm.
	P111657 00003 - 4SAFE SENSORE SICUR IR MONIT.SW/2MOD/900 Monitored IR safety sensor for side-hung leaves, 2 modules, 900 mm.		P111657 00002 - 4SAFE SENSORE SICUR IR MONIT.SW/2MOD/700 Monitored IR safety sensor for side-hung leaves, 2 modules, 700 mm.
	P111657 00001 - 4SAFE SENSORE SICUR IR MONIT.SW/1MOD/700 Monitored IR safety sensor for side-hung leaves, 1 module, 700 mm.		P111656 - VIO-ST Infrared safety sensor, monitored.



VISTA SW

	P111662 - VIO-M Compact mono-directional activation sensor.		P111756 - OA-EDGE T 340 1M Active infrared sensor for security L 340 mm with 1 module with safety test.
	P111757 - OA-EDGE T 700 1M Active infrared sensor for security L 700 mm with 1 module with safety test.		P111758 - OA-EDGE T 1200 2M Active infrared sensor for security L 1200 mm with 2 modules with safety test.
	P111759 - OT 3 Elbow-operated pushbutton, silver.		

AUTOMATION SYSTEMS FOR AUTOMATIC PEDESTRIAN DOORS



www.bft-automation.com

INFORMATIVA A TUTELA DEI DIRITTI DI PROPRIETA' INDUSTRIALE E INTELLETTUALE DI BFT. BFT S.p.A. tutela i propri diritti di proprietà industriale attraverso il deposito di marchi, brevetti, modelli e design. La proprietà intellettuale di BFT S.p.A. è tutelata a norma della legge sul diritto d'autore. BFT S.p.A. tutela inoltre il proprio know-how adottando misure di protezione delle informazioni tecniche e commerciali inerenti la propria azienda e i propri prodotti. Tutti i prodotti presenti in questo catalogo sono MODELLI ORIGINALI BFT e BFT S.p.A. è la sola autorizzata a produrli e commercializzarli in tutto il Mondo. Tutti i nomi commerciali attribuiti ai prodotti presenti in questo catalogo sono di titolarità di BFT S.p.A. che è la sola autorizzata al loro uso in relazione alla relativa categoria merceologica. I CONTRAFFATTORI VERRANNO PERSEGUITI A NORMA DI LEGGE SIA IN SEDE CIVILE CHE PENALE. IL TUTTO A GARANZIA NON SOLO DEL PATRIMONIO INTELLETTUALE DI BFT, MA ANCHE A TUTELA DEI CLIENTI CHE ACQUISTANDO PRODOTTI BFT ACQUISTANO PRODOTTI ORIGINALI FRUTTO DI STUDI E PROGETTI INTERNI ALLA SOCIETA' BFT.