

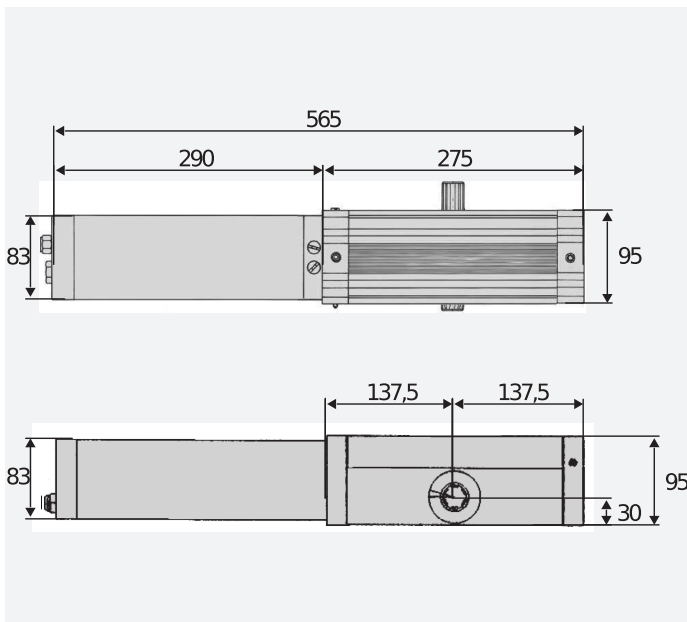

Hydraulic operator for very intensive use for industrial folding doors, maximum two panels per leaf. Designed for the toughest conditions of use, it combines strength and the typical reliability of hydraulic operators.

## DIMENSION (MM)



## INSTALLATION DIMENSIONS

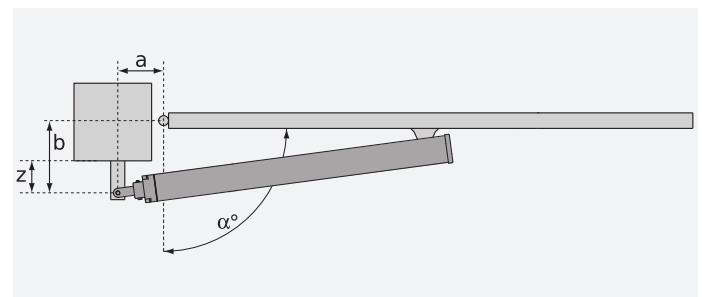



## TECHNICAL FEATURES

|                          | FORB  | FORB R  | FORB ERSA   |
|--------------------------|---|---|---|
| Control unit             |   | RIGEL 5   |   |
| Nominal voltage          | 230 V   | 230 V   | 230 V   |
| Power input              | 250 W   | 250 W   | 250 W   |
| Max surface area         | 6 m <sup>2</sup>                                    | 2.4 m <sup>2</sup>                                  | 2.4 m <sup>2</sup>                                  |
| Door surface area        | 6 m <sup>2</sup>                                    | 2.4 m <sup>2</sup>                                  | 2.4 m <sup>2</sup>                                  |
| Opening or closing time  | 25  | 13+slowdown   | 13+slowdown   |
| Slowdown                 | no  | Yes   | Yes   |
| Locking                  | Hydraulic   | Hydraulic   | Hydraulic   |
| Release                  | Lever or steel cable                                | Lever or steel cable                                | Lever or steel cable                                |
| Impact reaction          | Sure-safe anti-crushing system with 2 bypass valves | Sure-safe anti-crushing system with 2 bypass valves | Sure-safe anti-crushing system with 2 bypass valves |
| Frequency of use         | very intensive                                      | very intensive                                      | very intensive                                      |
| Protection rating        |   | IP57  | IP20  |
| Environmental conditions |   | -15 + 60 °C   |   |



|                          |                  | Description   |
|--------------------------|------------------|---|
| <b>P935017<br/>00001</b> | <b>FORB</b>      | Hydraulic operator for industrial folding doors (maximum two panels) of maximum surface area 6 m <sup>2</sup> and very intensive use. Anti-crushing.        |
| <b>P935019<br/>00001</b> | <b>FORB R</b>    | Hydraulic operator for industrial folding doors (maximum two panels) of maximum surface area 2.4 m <sup>2</sup> and very intensive use. Hydraulic slowdown. |
| <b>P935038<br/>00001</b> | <b>FORB ERSA</b> | Hydraulic operator for industrial folding doors (maximum two panels) of maximum surface area 2.4 m <sup>2</sup> and very intensive use. Hydraulic slowdown. |



## RECOMMENDED ACCESSORIES

|   |   |   |   |
|---|---|---|---|
|   | <b>D113833 00002 - RIGEL 6 220-230V 50/60HZ</b><br>Universal control panel with display for one or two 230V - 650+650W operators. |  | <b>N733020 - SEB</b><br>External key release for BERMA, FORB, IGEA LB and IGEA LB BT. |
|  | <b>P111407 - FALCON</b><br>Industrial presence sensor installable up to 7 m.  |   |   |



|                          |                  | Description   |
|--------------------------|------------------|---|
| <b>P935017<br/>00001</b> | <b>FORB</b>      | Hydraulic operator for industrial folding doors (maximum two panels) of maximum surface area 6 m <sup>2</sup> and very intensive use. Anti-crushing.        |
| <b>P935019<br/>00001</b> | <b>FORB R</b>    | Hydraulic operator for industrial folding doors (maximum two panels) of maximum surface area 2.4 m <sup>2</sup> and very intensive use. Hydraulic slowdown. |
| <b>P935038<br/>00001</b> | <b>FORB ERSA</b> | Hydraulic operator for industrial folding doors (maximum two panels) of maximum surface area 2.4 m <sup>2</sup> and very intensive use. Hydraulic slowdown. |

## RECOMMENDED ACCESSORIES

|   |  |   |   |
|---|--|---|---|
|   | <b>D113833 00002 - RIGEL 6 220-230V 50/60HZ</b>                                |  | <b>N733020 - SEB</b>  |
|   | Universal control panel with display for one or two 230V - 650+650W operators. |   | External key release for BERMA, FORB, IGEA LB and IGEA LB BT. |
|  | <b>P111407 - FALCON</b>  |   |   |
|   | Industrial presence sensor installable up to 7 m.                              |   |   |