

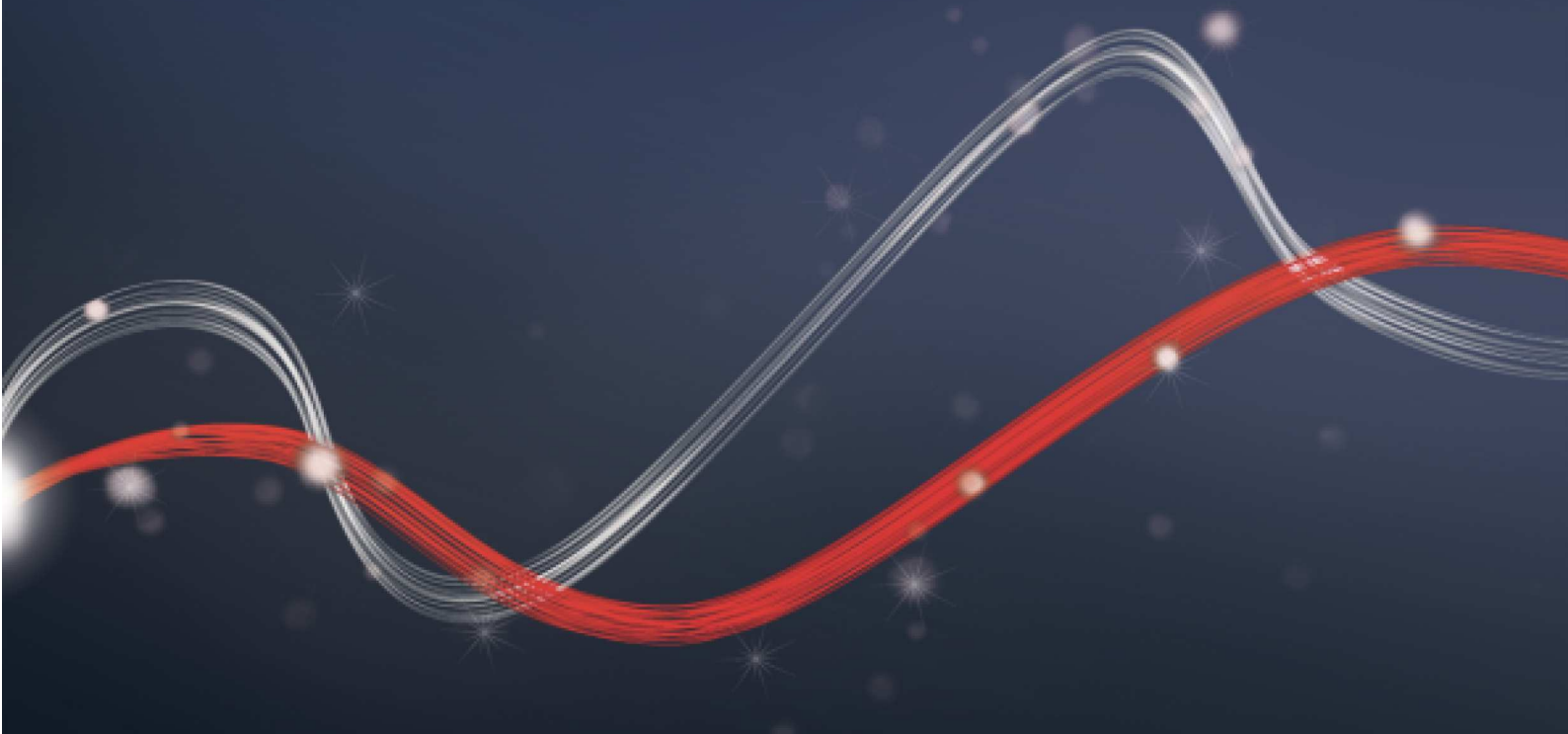

Be ahead



ATHOS AC A





Electromechanical automation systems for swing gates

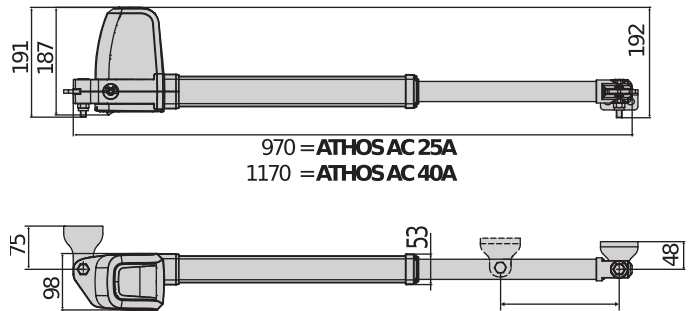

Thanks to the structure made of die-cast aluminium shells and to the high quality materials, such as the worm screw transmission system and the bronze crown, the Athos operator range ensures maximum strength, reliability and resistance over time. Quick to install, Athos also ensures maximum comfort, thanks to fast opening and closing combined with extremely silent operation. Non-reversible operator for residential use; the emergency manoeuvre is always easy thanks to unlocking with triangular key.

Relevant features



Compact design: Athos is designed to space saving and allows the maximum installation flexibility to be installed even in a niche.



Maximum comfort: the motor can open in just 14 sec at 90° (mod. A25) or 16 sec. (mod A40).

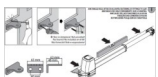

Ease of installation: front & rear brackets are aligned, so that the installation is easy & quick.



Strength & robustness: thanks to its sturdy structure and to its high-end materials such as die-cast aluminium shells and bronze crown transmission, Athos guarantees the maximum strength, reliability and longer life span.



Electromechanical automation systems for swing gates

ATHOS AC A

Code	Ci	Name	Description
P935108 00002	2611765	ATHOS AC A25 AR	Irreversible electromechanical operator 230 V for swing gates weighing up to 700 kg and 2.5 m long. Motor right.
P935109 00002	2611766	ATHOS AC A25 AL	Irreversible electromechanical operator 230 V for swing gates weighing up to 700 kg and 2.5 m long. Motor left.
P935115 00002	2611768	ATHOS AC A40 AR	Irreversible electromechanical operator 230 V for swing gates weighing up to 400 kg and 4 m long. Motor right.
P935116 00002	2611769	ATHOS AC A40 AL	Irreversible electromechanical operator 230 V for swing gates weighing up to 400 kg and 4 m long. Motor left.
R935339 00002	2611966	ATHOS AC KIT A25 EU	Complete kit 230 V for swing gates up to 700 kg in weight and 2.5 m in length.
R935344 00002	2611972	ATHOS AC KIT A40 EU	Complete kit 230 V for swing gates up to 400 kg in weight and 4 m in length.

ALENA SW2: Control panel with slow-down, dip switches and potentiometers for one or two 230V 400W+400W, operators for swing gates and industrial folding doors

Cp D113811 00004 - Ci 2607514 - ALENA SW2 - Recommended



- Application: control panel for one or two operators for swing gates
- Card power supply: 230 V single-phase
- Operators power supply: 230V single-phase 400W max each operator
- Main features: programming of trimmer and dip-switch, removable terminal block with standard colouring, integrated radio receiver, remote controlled pedestrian opening. Soft opening and closing (only with electromechanical motor), management of resistive safety edges 8K2/contact, management of verified safety devices, management of electronic locks, electronic control of motor torque (only with electromechanical motor), pressure surge when opening.
- Main functions: stays locked when closed, 3/4 step logic, partial opening, fast closing and self-diagnostics
- Compatibility: ALTAIR and ARIES



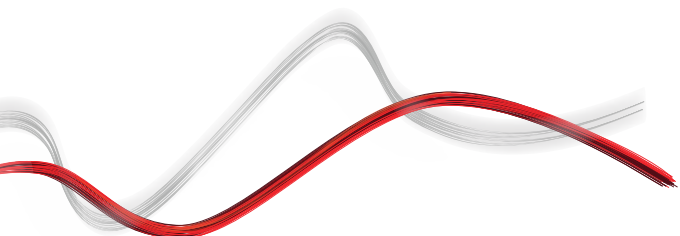









	ATHOS AC A25 AR	ATHOS AC A25 AL	ATHOS AC A40 AR	ATHOS AC A40 AL
Control unit	ALENA SW2	ALENA SW2	ALENA SW2	ALENA SW2
Board power supply	230 V	230 V	230 V	230 V
Motor voltage	230 V	230 V	230 V	230 V
Power consumption	280 W	280 W	280 W	280 W
Max. width of door/gate wing	2,5 m	2,5 m	4 m	4 m
Max. weight of door/gate wing	700 kg	700 kg	400 kg	400 kg
Useful rod stroke	300 mm	300 mm	400 mm	400 mm
Maximum angle	110 °	110 °	110 °	110 °
Cycle time	14 s	14 s	16 s	16 s
Type of limit switch	work time	work time	work time	work time
Slowdown	Yes	Yes	Yes	Yes
Locking	Mechanical	Mechanical	Mechanical	Mechanical
Release	Triangle key	Triangle key	Triangle key	Triangle key
Impact reaction	Electronic clutch	Electronic clutch	Electronic clutch	Electronic clutch
Frequency of use	Semi intensive	Semi intensive	Semi intensive	Semi intensive
Protection rating	IP54	IP54	IP54	IP54
Environmental conditions	-20 ÷ 55 °C	-20 ÷ 55 °C	-20 ÷ 55 °C	-20 ÷ 55 °C





Electromechanical automation systems for swing gates

RECOMMENDED ACCESSORIES

	Cp N999724 - Ci 2611153 PLE ATHOS Anchor plate for welding the mountings to masonry pillars for ATHOS operators		Cp D610180 - Ci 2600598 CLS Triangular release key l=52 mm
	Cp N190104 - Ci 2600775 BIR C Rubber safety edge (H 30 mm), price per m		Cp P111401 00001 - Ci 2600207 VENTIMIGLIA NS Infrared device for BIR C or BAR C safety edges (conforms to EN 12978 Standard)
	Cp D111013 - Ci 2607261 ME Control board for 12Vac solenoid lock for 230V automation systems		Cp D121018 - Ci 2600301 ECB VERTICALE Vertical solenoid lock, 12/24 V
	Cp D114093 00002 - Ci 2607538 RADIUS LED AC A R1 Flashing light with incorporated antenna for motors with 230 V power supply.		new Cp P123032 00001 - Ci 2613516 EBP AC A 230V 50/60HZ 230V vertical electric lock.
	Cp P111782 - Ci 2601411 COMPACTA A20-180 Pair of photocells adjustable 180° horizontally. 20 metre range. 12-33 VAC/15-35 VDC power supply.		new Cp P123032 00002 - Ci 2613517 EBP AC A 120V 50/60Hz 120V vertical electric lock.
	Ph. Out Cp P123001 00001 - Ci 2600836 EBP Electric lock 220-230V 50/60Hz with zero stop resistance		Cp P111052 - Ci 2600802 CM1700 Mechanical safety edge, length 1.7 m
	Cp P111053 - Ci 2600803 CM2000 Mechanical safety edge, length 2 m		

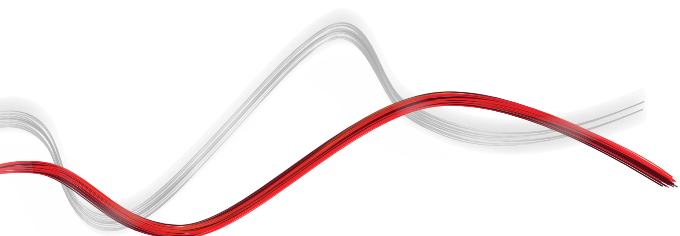



Electromechanical automation systems for swing gates

EasyAXS

EASY CONNECT. EASY ACCESS.



The new connectivity solution which boosts the potential of BFT products and services to make access automations smarter and easier to use for both installers and end users.

1

EASY TO CONNECT



PLUG&PLAY
CONNECTIVITY MODULE
FOR QUICKLY CONNECTING
BFT SOLUTIONS



2

EASY TO SET UP



CONFIGURATION
AND
MANAGEMENT OF
THE MOTOR WITH
THE **EasyAXS app**

3

EASY TO CONTROL



TaHoma app
TO PROVIDE CUSTOMERS
WITH A SMART SOLUTION
FOR ACCESSING THEIR
HOMES





Electromechanical automation systems for swing gates

EASY TO CONNECT

WIFI MODULE



→ 10/15 metres

WIFI MODULE + ANTENNA



→ 20/25 metres

MOBILE MODULE + ANTENNA + SIM



→ ∞



**PLUG&PLAY
INSTALLATION**



**ALWAYS
CONNECTED**



**EVEN MORE
CONNECTIVITY**



**EASY TO SET UP
FOR INSTALLERS**



**EASY TO CONTROL
FOR CUSTOMERS**





Electromechanical automation systems for swing gates



U-LINK 2.0

AN UPDATED VERSION OF
U-LINK TO GIVE YOU EVEN
MORE FUNCTIONALITY



Scalable

You can add as many devices as you want



Intuitive

Easy to install and to use



Functional

Settings can be controlled and firmware updated remotely using dedicated applications



Practical

Works with or without an internet connection



Flexible

It allows you to create groups of interconnected products

U-Link, the exclusive **BFT** technology platform has evolved to offer improved interaction with the latest generation of technological ecosystems. Its ability to interface with all home access automation access devices has been expanded, meaning it is now a very useful tool for installers. It is also a faster communication protocol with increased security for communicating information.

It allows you to save even more time, checking everything very easily and giving you even more peace of mind.



Electromechanical automation systems for swing gates

U-SECURITY

A NEW AND EVEN MORE SECURE RADIO PROTOCOL



- **Secure**
By transmitting data protected by a cryptographic key

U-Security is the new technology from **BFT** which incorporates encrypted rolling code thanks to the encryption key which masks the remote control code, meaning that it is impossible to clone a BFT remote control using another brand's model.

The functions of the **Er Ready** system are incorporated and a new procedure is also available for programming remote controls by scanning a QR CODE and using a special app. All products featuring this technology are **REPLAY**, so they can transmit the code to another BFT remote control using a combination of keys.



- **Easy**
Pairing a remote control with a receiver can be done easily by scanning the QR code and using the dedicated app



- **Universal**
The radio protocol is also compatible with the previous generation of receivers



INFORMATION REGARDING THE PROTECTION OF THE INDUSTRIAL AND INTELLECTUAL PROPERTY RIGHTS OF BFT. BFT S.p.A. protects its industrial property by depositing trademarks, patents, models and designs. The intellectual property of BFT S.p.A. is protected by copyright law. BFT S.p.A. also protects its know-how by taking measures to protect the technical and commercial information inherent in its company and products. All the products in this catalogue are ORIGINAL BFT MODELS and only BFT S.p.A. is authorised to produce them and market them anywhere in the world. All the commercial names in this catalogue are owned by BFT S.p.A., and only BFT S.p.A. is authorised to use them in relation to the corresponding merchandise category. **FALSIFIERS WILL BE PROCEEDED AGAINST IN ACCORDANCE WITH BOTH CIVIL AND CRIMINAL LAW. THESE CONDITIONS NOT ONLY GUARANTEE THE INTELLECTUAL PROPERTY RIGHTS OF BFT, BUT ALSO PROTECT CUSTOMERS BY GUARANTEEING THAT THE PRODUCTS THEY ARE PURCHASING ARE ORIGINAL BFT PRODUCTS RESULTING FROM STUDIES AND DESIGNS WITHIN THE BFT COMPANY.**