



Be ahead



EBP A



Electric locks for automatic gates

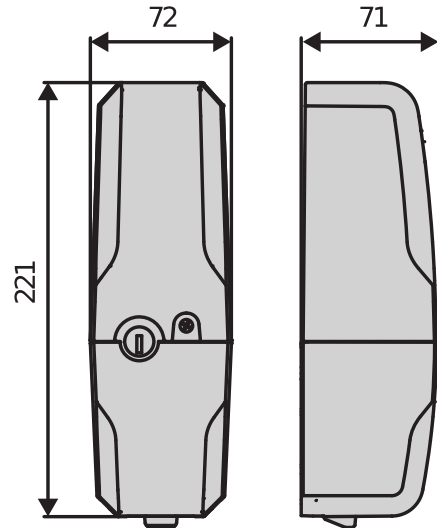

Vertical drop-down electric lock, for automated swinging gates. The product is an important accessory for completing the installation in order to safeguard gear motors installed on large gates. It is also an essential element for locking the leaves when gates are equipped with reversible operators. Available in 230V, 120V and in the new 24V version, it is directly connected to the control unit. The wide operating temperature range of -20°C $+55^{\circ}\text{C}$ allows it to be used in a large number of applications.

Relevant features

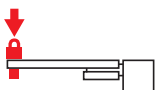

Higher protection for the installation: the electric lock makes it possible to create installations that better withstand the forces applied to the leaves in swinging gates, especially large ones, such as pushes from people or forces generated by the action of the wind. These forces are transferred to the electromechanical lock instead of the gear motor, providing a longer life and better operation over time



Offer completion for reversible operators: the electric lock is an essential accessory for installations involving the use of reversible operators, in order to provide locking for the gate when closing

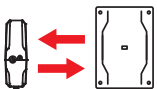

Range extension: the new EBP A model in 24V, which is directly connected to the control unit, allows safe low-voltage swing gate installations to be completed easily and quickly

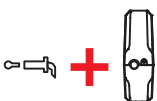

Range optimisation: there will no longer be any specific electric lock models (EBPE) with an external (road side) key block. In all models of the new EBP A it is possible at any time to add the external key block, which is available in two sizes of 52 or 75 mm. The accessory also includes the inside key block, which has the same key as the outside key block, and which should be replaced with the one on the electric lock by the installer

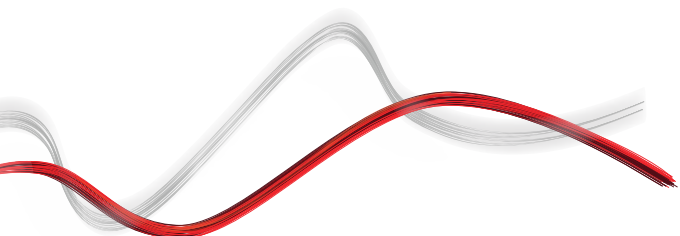

Electric locks for automatic gates

Relevant features

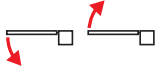

Outward opening: the EBP A electric lock can be installed either on swing gates that open inwards or on gates that open outwards (the plate with the ground hole must be installed in the correct direction)

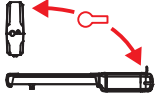

Simplicity of a single key for the entire system: it is possible to request the new EBP A with a specific internal key block, or request accessories with internal and external blocks with a specific key number, so that the same key can be used to unlock the operator, operate the selector switch and release the electric lock

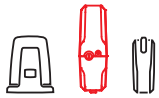

Design: the look of the product has been updated - in line with Bft's modern style - allowing it to be perfectly integrated into the installation environment

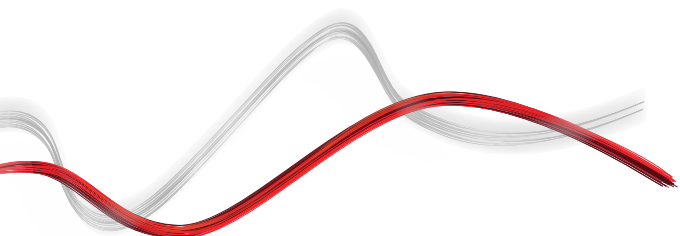

Electric locks for automatic gates

EBP A

Code	Ci	Name		Description
P123032 00001	2613516	EBP AC A 230V 50/60HZ		230V vertical electric lock.
P123032 00003	2613518	EBP BT A 24V		24V vertical electric lock.
P123032 00002	2613517	EBP AC A 120V 50/60Hz		120V vertical electric lock.
P123001 00001	2600836	EBP		Electric lock 220-230V 50/60Hz with zero stop resistance
P123001 00013	2600520	EBP 24		Electric lock 120/230V 50/60Hz with 230/24V transformer which can be installed on the control panel
P123006 00001	2600500	EBPE 52		Electric lock 220-230V 50/60Hz with zero stop resistance, also with external release for gates of max. thickness 52 mm.
P123006 00013	2611411	EBPE 52 24V		EBPE 52 120/230V 50/60Hz with transformer
P123008 00001	2600519	EBPE 75		Electric lock 220-230V 50/60Hz with zero stop resistance, also with external release for gates of max. thickness 75 mm.
P123001 00004	2611406	EBP 120		Electric lock 120V 50/60Hz with 230/24V transformer which can be installed on the control panel

	EBP AC A 230V 50/60HZ	EBP BT A 24V	EBP AC A 120V 50/60Hz	EBP	EBP 24
Power supply	220-230V 50/60 Hz	24V ± 10% 50/60 Hz or DC	120V 50/60 Hz	220-230V 50/60Hz	120/230V 50/60Hz
Inrush current	1,2 A	1,2 A	1,2 A	0,4 A	15 A
Holding current for the retracted bolt	200 mA	1000 mA	400 mA	150 mA	1450 mA
Thermal protection	Yes	Yes	Yes	Yes	Yes
Operating temperature	-20 ÷ 55 °C	-20 ÷ 55 °C	-20 ÷ 55 °C	-20 ÷ 55 °C	-20 ÷ 55 °C
IP Rating	IP44	IP44	IP44	IP44	IP44

	EBPE 52	EBPE 52 24V	EBPE 75	EBP 120
Power supply	220-230V 50/60Hz	120/230V 50/60Hz	220-230V 50/60Hz	120V 50/60Hz
Inrush current	0,4 A	15 A	0,4 A	0,84 A
Holding current for the retracted bolt	150 mA	1450 mA	150 mA	260 mA
Thermal protection	Yes	Yes	Yes	Yes
Operating temperature	-20 ÷ 55 °C	-20 ÷ 55 °C	-20 ÷ 55 °C	-20 ÷ 55 °C
IP Rating	IP44	IP44	IP44	IP44

RECOMMENDED ACCESSORIES

<p>Cp P123033 - Ci 2613523 CSE 52 (EXTERNAL RELEASE EBP 52 MM)</p> <p>Key cylinder for external release for gates of max. thickness 50 mm. Also includes internal key cylinder with same key number.</p>	<p>Cp P123034 - Ci 2613525 CSE 75 (EXTERNAL RELEASE EBP 75 MM)</p> <p>Key cylinder for external release for gates of max. thickness 75 mm. Also includes internal key cylinder with same key number.</p>
-----------------------------------------------------------------------------------------------------------------------------------------------------------------------------------------------------------------------------------	-----------------------------------------------------------------------------------------------------------------------------------------------------------------------------------------------------------------------------------

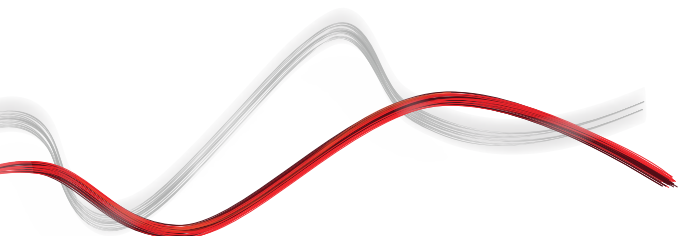



INFORMATION REGARDING THE PROTECTION OF THE INDUSTRIAL AND INTELLECTUAL PROPERTY RIGHTS OF BFT. BFT S.p.A. protects its industrial property by depositing trademarks, patents, models and designs. The intellectual property of BFT S.p.A. is protected by copyright law. BFT S.p.A. also protects its know-how by taking measures to protect the technical and commercial information inherent in its company and products. All the products in this catalogue are ORIGINAL BFT MODELS and only BFT S.p.A. is authorised to produce them and market them anywhere in the world. All the commercial names in this catalogue are owned by BFT S.p.A., and only BFT S.p.A. is authorised to use them in relation to the corresponding merchandise category. **FALSIFIERS WILL BE PROCEEDED AGAINST IN ACCORDANCE WITH BOTH CIVIL AND CRIMINAL LAW. THESE CONDITIONS NOT ONLY GUARANTEE THE INTELLECTUAL PROPERTY RIGHTS OF BFT, BUT ALSO PROTECT CUSTOMERS BY GUARANTEEING THAT THE PRODUCTS THEY ARE PURCHASING ARE ORIGINAL BFT PRODUCTS RESULTING FROM STUDIES AND DESIGNS WITHIN THE BFT COMPANY.**