



Be ahead



QUADRO VARCO





QUADRO VARCO



ESPAS 30 ULTRA

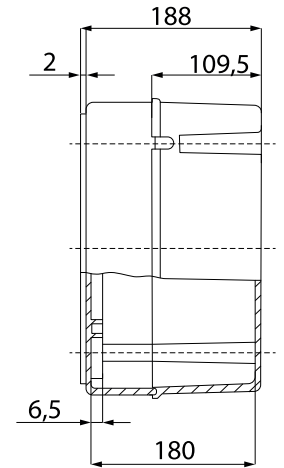
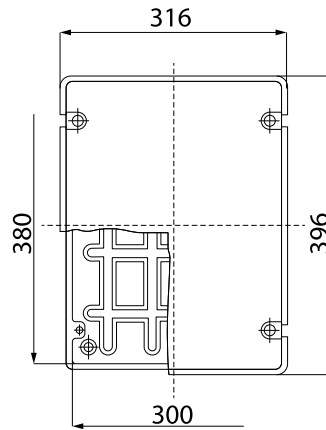
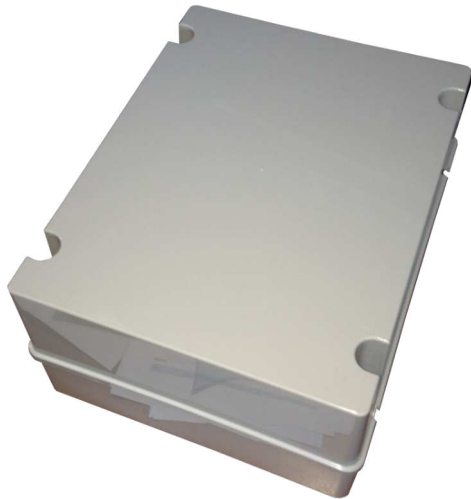

The Quadro Varco is designed as a device for count management in wired systems within a parking area or sub-area, for entry/exit gates. The parking management software can be used to control the operating modes of any barrier connected to the gate controller. The device can manage up to 2 gates











ESPAS 30 ULTRA

QUADRO VARCO

Code	Ci	Name	Description
FP208002	2606020	QUADRO VARCO	The Quadro Varco is a product that allows counting of entrances and exit of areas or sub-areas within the all Parking area.

QUADRO VARCO	
Supply voltage	230 VAC ±10%, 50Hz-60Hz
Max power consumption	70 W
Operating temperature	-10 ÷ 50 °C
Sizes	316 x 396 x 188 mm
Standard communication interface	RS485
Protection rating	IP57

RECOMMENDED ACCESSORIES

	Cp D110945 - Ci 2607227 MAGNETIC LOOP 5MT High sensivity pre-cabled magnetic loop (10m tail x 5m loop)		Cp D141784 - Ci 2607232 MAGNETIC LOOP 8MT High sensivity pre-cabled magnetic loop (10m tail x 8m loop)
	Cp D113999 - Ci 2605754 LOOP DETECTOR LITE 2 channel loop detector, 24VDC, up to 4 frequencies per channel for close loop installations, adjustable sensitivity, boost function for sensitivity increase		Cp D113948 - Ci 2605737 LOOP DETECTOR PRO 2 channel loop detector, 24VDC/AC, up to 4 frequencies per channel for close loop installations, adjustable sensitivity, boost function for sensitivity increase. Direction detection.
	Cp 394080 - Ci 2607023 PRESENCE AND SAFETY DETECTOR - LASER LOOPS Presence and Safety laser detector. Its used as an alternative of magnetic loops. Includes one input and two relay outputs. Maximum detection range: 9.9m x 9.9m. 10-35VDC power supply.		Cp 394073 - Ci 2604478 LASER SAFETY SENSOR Safety laser detector. Its used in combination with magnetic loops in order to add an additional safety device (eg: for pedestrian). Includes two relay outputs. Maximum detection range: 5m x 5m. 10-35VDC power supply.
	Cp 394071 - Ci 2604477 LBA FIXING BRACKET Fixing bracket for LASER DETECTOR for ceiling or post mounted applications.		Cp 394075 - Ci 2607020 LASER DETECTOR REMOTE CONTROL Remote control for settings Safety laser detector and Presence and Safety laser detector.

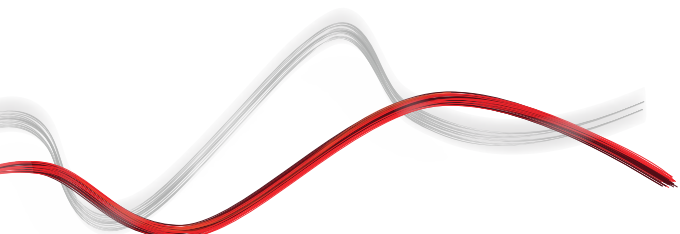



INFORMATION REGARDING THE PROTECTION OF THE INDUSTRIAL AND INTELLECTUAL PROPERTY RIGHTS OF BFT. BFT S.p.A. protects its industrial property by depositing trademarks, patents, models and designs. The intellectual property of BFT S.p.A. is protected by copyright law. BFT S.p.A. also protects its know-how by taking measures to protect the technical and commercial information inherent in its company and products. All the products in this catalogue are ORIGINAL BFT MODELS and only BFT S.p.A. is authorised to produce them and market them anywhere in the world. All the commercial names in this catalogue are owned by BFT S.p.A., and only BFT S.p.A. is authorised to use them in relation to the corresponding merchandise category. FALSIFIERS WILL BE PROCEEDED AGAINST IN ACCORDANCE WITH BOTH CIVIL AND CRIMINAL LAW. THESE CONDITIONS NOT ONLY GUARANTEE THE INTELLECTUAL PROPERTY RIGHTS OF BFT, BUT ALSO PROTECT CUSTOMERS BY GUARANTEEING THAT THE PRODUCTS THEY ARE PURCHASING ARE ORIGINAL BFT PRODUCTS RESULTING FROM STUDIES AND DESIGNS WITHIN THE BFT COMPANY.