



Be ahead



ICARO VELOCE SMART AC A





ICARO VELOCE SMART AC A



Sliding gate automation systems



Encoder



Oil Gear



U-Link



rolling code



d-track



er ready



ee link

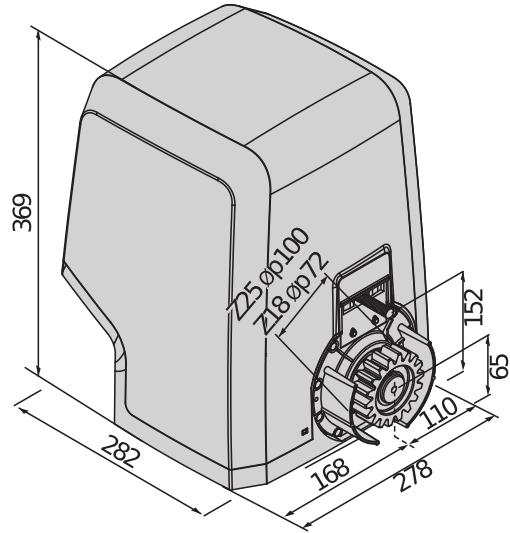

Fast 230V operators for sliding gates for very intensive use, extremely robust and high-performance thanks to oil bath transmission. Suitable for sliding gates weighing up to 1,000kg and speed without load 25 m/min or up to 2,000 kg and speed without load 18 m/min. The maximum speed actually achievable by the gate panel depends on the condition of the gate. Operator fitted with electromechanical limit switch. Torque control thanks to D-Track technology and encoder for the highest possible precision of movement. Control unit for communication with U-Link protocol and with tamper-proof function. The ideal solution for situations which require fast operating speeds, reduced waiting times and high levels of security.

Relevant features



Speed: The fast opening of the ICARO VELOCE SMART AC reduces waiting times, allowing quicker access, particularly useful for commercial and industrial sites.



security

Security: The fast operating speed means that the ICARO VELOCE SMART AC closes quickly, reducing the risk of entry by unauthorised people.



U-LINK

U-Link: The ICARO VELOCE SMART AC A 1000 operator is compatible with the U-Link communication protocol, through the integrated LEO B CBB control panel.



d-track

D-Track dynamic path tracking: smart torque management system that constantly updates the gate torque level, improving the safety of the maneuver regardless of weather conditions, temperature or the degree of wear of the system.

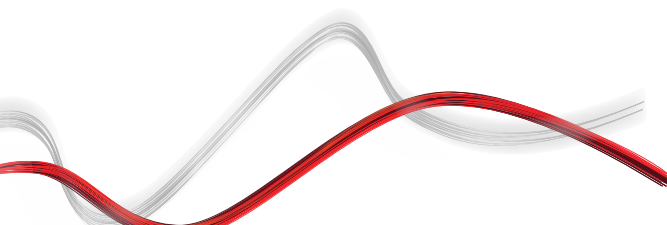



Sliding gate automation systems



Relevant features



Oil Gear

Oil Gear: Oil bath gearbox unit. The component gears of the transmission are immersed in an oil bath to ensure perfect lubrication throughout their service life.

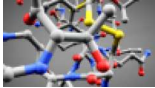

Technopolymers: The combined use of metal and plastic-technopolymer gears provides the perfect engagement between the surfaces, allowing for reduced friction and the highest levels of reliability in intensive use.



Personalised key: The lever release makes it easy to release the motor and the personalised key is unique, providing increased security.



Screws on the front: By putting the fastening screws on the front of the casing, installation and maintenance are easier and more convenient, even in confined spaces.

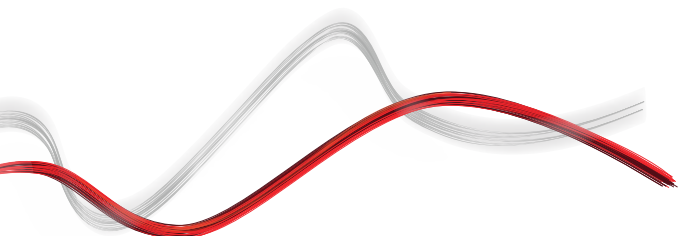



Sliding gate automation systems



ICARO VELOCE SMART AC A

Code	Ci	Name	Description	
P925256 00002	2601413	ICARO VELOCE SMART AC A1000	Operator 230 V for sliding gates weighing up to 1000 kg with encoder. Gate panel speed 25 m/min. With mechanical safety clutch, manages torque using D-Track technology and oil bath gearbox. Electromechanical limit switch. Control unit with display, preconfigured for communication with U-Link protocol	U-Link
P925265 00002	2613179	ICARO VELOCE SMART AC A2000	Operator 230 V for sliding gates weighing up to 2000 kg with encoder. Gate panel speed 18 m/min. With mechanical safety clutch, manages torque using D-Track technology and oil bath gearbox. Electromechanical limit switch. Control unit with display, preconfigured for communication with U-Link protocol	U-Link
P925256 00001	2613178	ICARO VELOCE SMART AC A1000 120V 60HZ	Operator 120 V for sliding gates weighing up to 1000 kg with encoder. Gate panel speed 22 m/min. With mechanical safety clutch, manages torque using D-Track technology and oil bath gearbox. Electromechanical limit switch. Electromechanical limit switch. Control unit with display, preconfigured for communication with U-Link protocol.	U-Link

LEO B CBB SV: Built-in control panel for 1 x 230V operator for sliding gates

LEO B CBB SV - **Cp** I700098 10001 - **Ci** 2601475 - Built-in - (Spare parts code for ICARO VELOCE SMART AC A1000 which are available for order via the Technical Support network)



- Built-in control panel for 1 x 230V operator for sliding gates
- Application: built-in control unit for one 230V operator for sliding gates
- Card power supply: 230 V single-phase
- Operator power supply: 230V 750W
- Main features: removable terminal blocks with new standard colour-coding, simplified scenario-based programming with display, incorporated dual channel receiver, D-Track anti-crushing system, slowdown during opening and closing
- Main functions: automatic re-closing, fast closing, pedestrian opening

LEO B CBB SV 18D: Built-in control panel for 1 x 230V operator for sliding gates

LEO B CBB SV 18D - **Cp** I700125 10001 - **Ci** 2613257 - Built-in - (Spare parts code for ICARO VELOCE SMART AC A2000 which are available for order via the Technical Support network)



- Built-in control panel for 1 x 230V operator for sliding gates
- Application: built-in control unit for one 230V operator for sliding gates
- Card power supply: 230 V single-phase
- Operator power supply: 230V 750W
- Main features: removable terminal blocks with new standard colour-coding, simplified scenario-based programming with display, incorporated dual channel receiver, D-Track anti-crushing system, slowdown during opening and closing
- Main functions: automatic re-closing, fast closing, pedestrian opening

	ICARO VELOCE SMART AC A1000	ICARO VELOCE SMART AC A2000	ICARO VELOCE SMART AC A1000 120V 60HZ
Control unit	LEO B CBB SV	LEO B CBB SV 18D	LEO B CBB SV
Board power supply	230 V	230 V	120 V
Motor voltage	230 V	230 V	120 V
Power consumption	750 W	750 W	750 W
Pinion module	4 mm (25 teeth)	4 mm (18 teeth)	4 mm (18 teeth)
Gate panel speed	25 m/min	18 m/min	22 m/min
Max. door/gate weight	1000 kg	2000 kg	1000 kg
Max torque	40 Nm	40 Nm	40 Nm
Slowdown	Yes	Yes	Yes
Impact reaction	8K2 safety edge (not supplied)	8K2 safety edge (not supplied)	8K2 safety edge (not supplied)
Locking	Mechanical	Mechanical	Mechanical
Manual cycle	Mechanical release with lever	Mechanical release with lever	Mechanical release with lever
Frequency of use	very intensive	very intensive	very intensive
Protection rating	IP24	IP24	IP24



ICARO VELOCE SMART AC A















Sliding gate automation systems



	ICARO VELOCE SMART AC A1000	ICARO VELOCE SMART AC A2000	ICARO VELOCE SMART AC A1000 120V 60HZ
Environmental conditions	-15 ÷ 55 °C	-15 ÷ 55 °C	-15 ÷ 55 °C

RECOMMENDED ACCESSORIES

	Cp D571054 - Ci 2608387 CFZ galvanized steel rack, 4-module, cross-section 22 x 22 mm, length 2 m, welding attachment Max. load capacity 2000 kg.		Cp N999156 - Ci 2611078 SFI Base plate for ARES and ICARO (supplied with operator)
	Cp P125018 - Ci 2600843 THEKE B PRA 01 Metal protection box for ARES and ICARO series sliding operators		 Cp P111468 - Ci 2600811 B EBA RS 485 LINK Expansion board for connection of central units with serial controls management
	Cp R920110 - Ci 2611808 EDGE XL-CP99A36/CA/2000/8K/5 BFT Kit for 8k2 resistive safety edges, length 2 metres, with 99 mm-high EPDM rubber strip, aluminium section, 2 contact terminals, 2 caps, 1 x 8.2 kOhm resistance connector and connection cable.		 Cp R920111 - Ci 2611809 KIT WIRELESSBAND 2.R Wireless transmission system for resistive safety edges comprising transmitter and receiver.
	 Cp P125050 - Ci 2611437 TX WIRELESSBAND 2.R Wireless transmitter for resistive safety edges.		Cp D114093 00002 - Ci 2607538 RADIUS LED AC A R1 Flashing light with incorporated antenna for motors with 230 V power supply.
	Cp D114094 00002 - Ci 2607540 RADIUS LED AC A R0 Flashing light without incorporated antenna for motors with 230 V power supply.		Cp P111782 - Ci 2601411 COMPACTA A20-180 Pair of photocells adjustable 180° horizontally. 20 metre range. 12-33 VAC/15-35 VDC power supply.

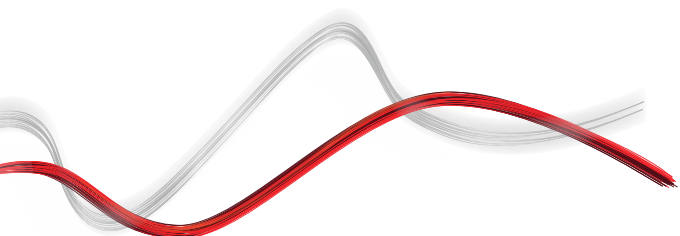



Sliding gate automation systems



Empowered by
U-LINK

EasyAXS

EASY CONNECT. EASY ACCESS.



The new connectivity solution which boosts the potential of BFT products and services to make access automations smarter and easier to use for both installers and end users.

1



EASY TO CONNECT



PLUG&PLAY
CONNECTIVITY MODULE
FOR QUICKLY CONNECTING
BFT SOLUTIONS



2

EASY TO SET UP



CONFIGURATION
AND
MANAGEMENT OF
THE MOTOR WITH
THE **EasyAXS app**

3

EASY TO CONTROL



TaHoma app
TO PROVIDE CUSTOMERS
WITH A SMART SOLUTION
FOR ACCESSING THEIR
HOMES





Sliding gate automation systems



EASY TO CONNECT

WIFI MODULE



→ 10/15 metres

WIFI MODULE
+ ANTENNA



→ 20/25 metres

MOBILE MODULE
+ ANTENNA + SIM



→ ∞



**PLUG&PLAY
INSTALLATION**



**ALWAYS
CONNECTED**



**EVEN MORE
CONNECTIVITY**



**EASY TO SET UP
FOR INSTALLERS**



**EASY TO CONTROL
FOR CUSTOMERS**





Sliding gate automation systems



U-LINK 2.0

AN UPDATED VERSION OF
U-LINK TO GIVE YOU EVEN
MORE FUNCTIONALITY



Scalable

You can add as many devices as you want



Intuitive

Easy to install and to use



Functional

Settings can be controlled and firmware updated remotely using dedicated applications



Practical

Works with or without an internet connection



Flexible

It allows you to create groups of interconnected products

U-Link, the exclusive **BFT** technology platform has evolved to offer improved interaction with the latest generation of technological ecosystems. Its ability to interface with all home access automation access devices has been expanded, meaning it is now a very useful tool for installers. It is also a faster communication protocol with increased security for communicating information.

It allows you to save even more time, checking everything very easily and giving you even more peace of mind.



Sliding gate automation systems



Empowered by
U-LINK

U-SECURITY

A NEW AND EVEN MORE SECURE RADIO PROTOCOL



Secure

By transmitting data protected by a cryptographic key

U-Security is the new technology from **BFT** which incorporates encrypted rolling code thanks to the encryption key which masks the remote control code, meaning that it is impossible to clone a BFT remote control using another brand's model.

The functions of the **Er Ready** system are incorporated and a new procedure is also available for programming remote controls by scanning a QR CODE and using a special app. All products featuring this technology are **REPLAY**, so they can transmit the code to another BFT remote control using a combination of keys.



Easy

Pairing a remote control with a receiver can be done easily by scanning the QR code and using the dedicated app



Universal

The radio protocol is also compatible with the previous generation of receivers

