

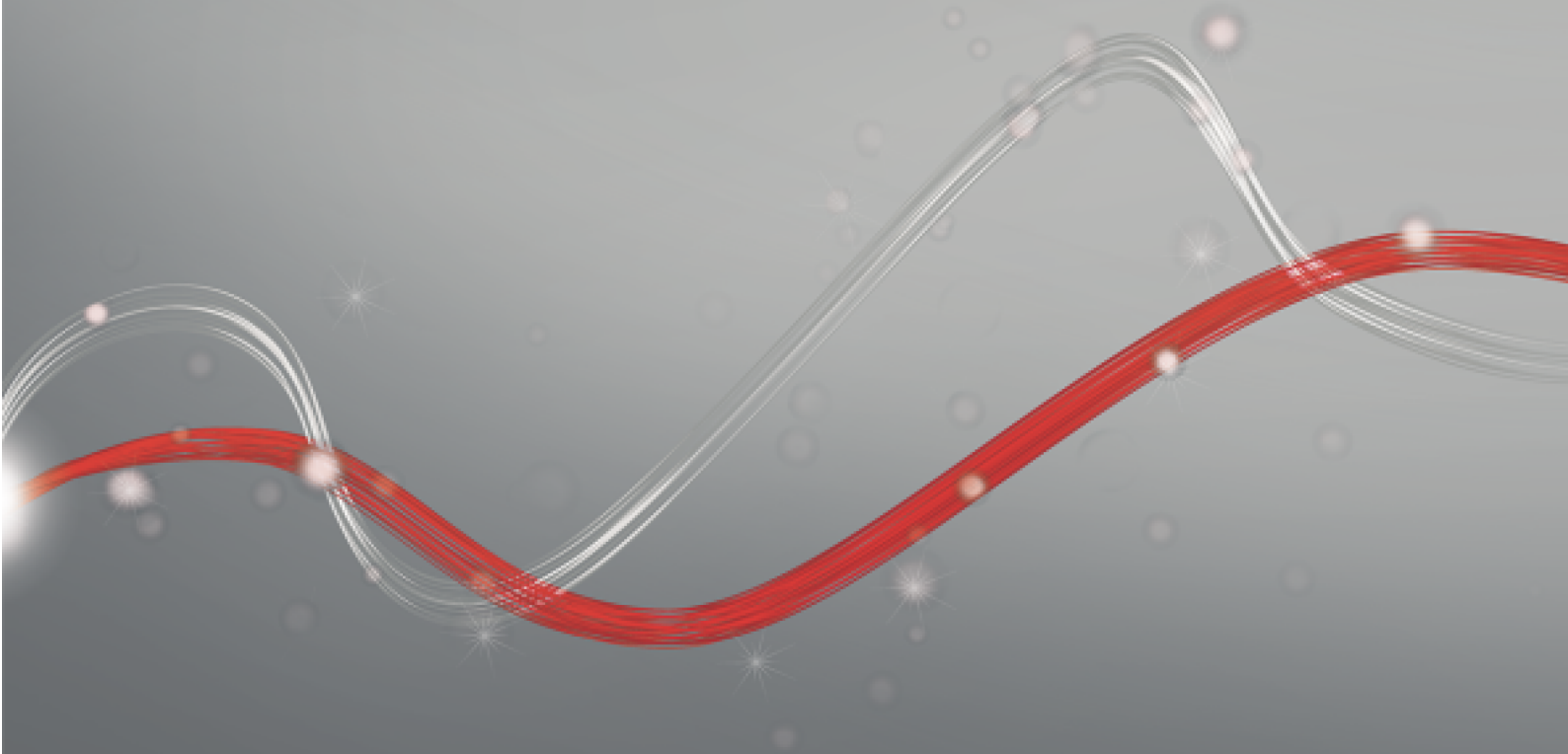

Be ahead



ESPAS 30-A ULTRA





ESPAS 30-A ULTRA



ESPAS 30 ULTRA

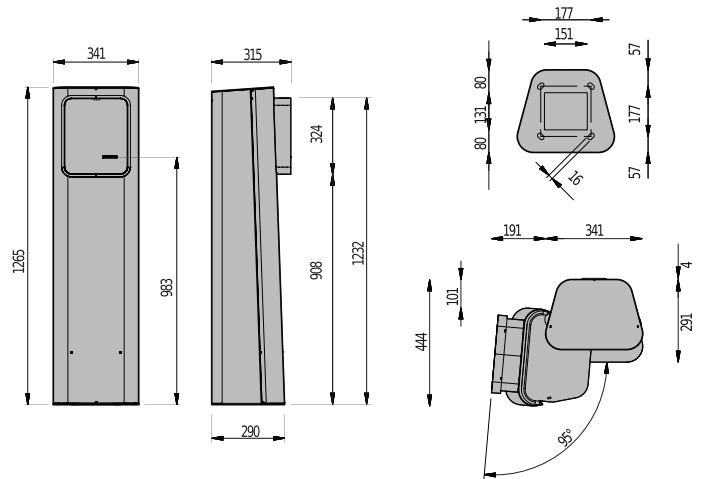

The ESPAS 30-A ULTRA station is a device for controlling an entry or exit transit point of a parking area. The unit works in a wired network as a component between the other elements of the system. This device allows to manage subscribers and operator card. The display and voice messages guide improve the user experience.

ESPAS 30-A ULTRA	
Supply voltage	230 VAC ±10%, 50Hz-60Hz
Max power consumption	200 W
Idle power consumption	70 W
Operating temperature	-20 ÷ 50 °C
Sizes	1265 x 341 x 315 mm
Gross weight	60 kg
Standard communication interface	RS485
Standard color	RAL7015
Material	Cabinet in 2,0 mm thick DD11 (UNI EN 10111) steel sheet; front panel in anti-wear and anti-scratch polycarbonate,

Code	Name	IP intercom	Bus intercom	RFID card reader	Double height low & high vehicle	Ethernet
PA5D040R10000	ESPAS 30-A ULTRA RF			●		
PA5D040R11000	ESPAS 30-A ULTRA RF CIT-BUS		●	●		
PA5D040R12000	ESPAS 30-A ULTRA RF CIT-IP	●		●		

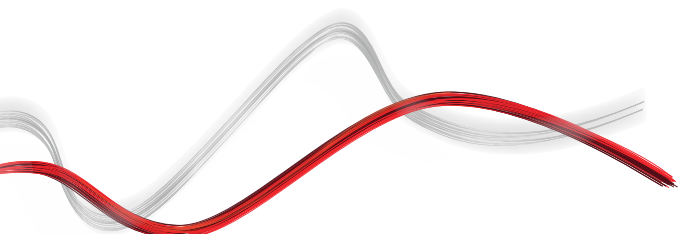

















ESPAS 30-A ULTRA



ESPAS 30 ULTRA

Code	Name	IP intercom	Bus intercom	RFID card reader	Double height low & high vehicle	Ethernet
PA5D060R12000	ESPAS 30-A ULTRA RF CIT-IP T NEW	●		●		●
PA8D040R10000	ESPAS 30-AH ULTRA RF			●	●	
PA8D040R11000	ESPAS 30-AH ULTRA RF CIT-BUS		●	●	●	
PA8D040R12000	ESPAS 30-AH ULTRA RF CIT-IP	●		●	●	

RECOMMENDED ACCESSORIES

	Cp 21261 - Ci 2606001 KIT STATIONS ANCHOR BASE Column anchor base for 20/30 entry/exit terminals		Cp D110945 - Ci 2607227 MAGNETIC LOOP 5MT High sensitivity pre-cabled magnetic loop (10m tail x 5m loop)
	Cp D141784 - Ci 2607232 MAGNETIC LOOP 8MT High sensitivity pre-cabled magnetic loop (10m tail x 8m loop)		Cp D121711 - Ci 2605801 HEATER UNIT Heater unit 60W for internal station/POF installation on DIN bar
	Cp 385251 - Ci 2604460 TRAFFIC LIGHT 2 LED 100MM Traffic light with two LED lights (red - green) with high brightness for transit regulation. Complete with LED lamps. Diam. 100mm		NEW Cp P800174 - Ci 2451276 TRAFFIC LIGHT 2 LED 200MM Two LED lights (red/green), high brightness racing-style traffic light system for controlling movements. With LED bulbs. Diameter 200mm.
	Cp 385256 - Ci 2604461 TRAFFIC LIGHT 3 LED 100MM Traffic light with three LED lights (red - red - green) with high brightness for transit regulation. Complete with LED lamps. Diam. 100mm		Cp D413445 - Ci 2605793 TRUCK HEIGHT PEDESTAL 800MM 800mm height pedestal, with door, for entry/exit column
	Cp D413530 - Ci 2605794 BUS HEIGHT PEDESTAL 600MM 600mm height pedestal, with door, for entry/exit column		Cp D113999 - Ci 2605754 LOOP DETECTOR LITE 2 channel loop detector, 24VDC, up to 4 frequencies per channel for close loop installations, adjustable sensitivity, boost function for sensitivity increase
	Cp D113948 - Ci 2605737 LOOP DETECTOR PRO 2 channel loop detector, 24VDC/AC, up to 4 frequencies per channel for close loop installations, adjustable sensitivity, boost function for sensitivity increase. Direction detection.		Cp P800138 - Ci 2606835 KIT DENEBO TO DENEBO Additional board used to communicate between two stations in "Two Ways" and "Double Height" configuration. For 30 system only.
	Cp P800137 - Ci 2606776 KIT INTERLOCK FOR PARKING Kit for manage interlock function (station between two barriers), useful to prevent queues on the gate or for particularly security requirements. It's usable when a third loop management is required (e.g. motorbike). Includes a loop detector for the second barrier safety loop and a kit of terminals in order to connect the commands of the second barrier.		Cp 394080 - Ci 2607023 PRESENCE AND SAFETY DETECTOR - LASER LOOPS Presence and Safety laser detector. Its used as an alternative of magnetic loops. Includes one input and two relay outputs. Maximum detection range: 9.9m x 9.9m. 10-35VDC power supply.
	Cp 394071 - Ci 2604477 LBA FIXING BRACKET Fixing bracket for LASER DETECTOR for ceiling or post mounted applications.		Cp 394075 - Ci 2607020 LASER DETECTOR REMOTE CONTROL Remote control for settings Safety laser detector and Presence and Safety laser detector.



ESPAS 30 ULTRA

RECOMMENDED ACCESSORIES



Cp P800132 - **Ci** 2606775
485-TCP/IP CONVERTER KIT

The device allows the insertion within a wired TCP/IP network of devices using an RS-485 serial interface. The solution is used in all those realities where it is necessary to transmit serial data through, for example, a local network already present.



Cp 394160 - **Ci** 2604482
PALO ø60 H3600

Galvanized steel pole support for panels and traffic lights.
Diam. 60mm - h 3600mm

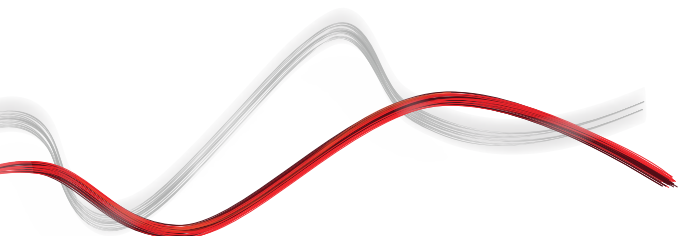



INFORMATION REGARDING THE PROTECTION OF THE INDUSTRIAL AND INTELLECTUAL PROPERTY RIGHTS OF BFT. BFT S.p.A. protects its industrial property by depositing trademarks, patents, models and designs. The intellectual property of BFT S.p.A. is protected by copyright law. BFT S.p.A. also protects its know-how by taking measures to protect the technical and commercial information inherent in its company and products. All the products in this catalogue are ORIGINAL BFT MODELS and only BFT S.p.A. is authorised to produce them and market them anywhere in the world. All the commercial names in this catalogue are owned by BFT S.p.A., and only BFT S.p.A. is authorised to use them in relation to the corresponding merchandise category. FALSIFIERS WILL BE PROCEEDED AGAINST IN ACCORDANCE WITH BOTH CIVIL AND CRIMINAL LAW. THESE CONDITIONS NOT ONLY GUARANTEE THE INTELLECTUAL PROPERTY RIGHTS OF BFT, BUT ALSO PROTECT CUSTOMERS BY GUARANTEEING THAT THE PRODUCTS THEY ARE PURCHASING ARE ORIGINAL BFT PRODUCTS RESULTING FROM STUDIES AND DESIGNS WITHIN THE BFT COMPANY.