



Be ahead



ESPAS 20-U





ESPAS 20-U



ESPAS 20

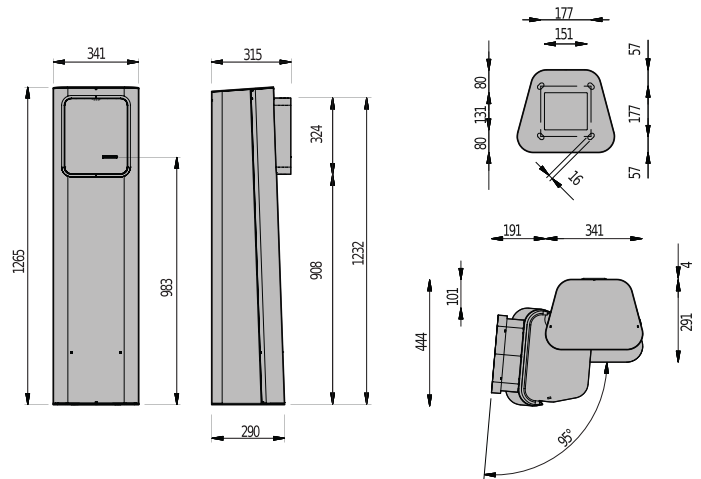

The ESPAS 20-U station combined with an electromechanical barrier is a device for controlling an exit transit point of a parking area. The system works in stand alone mode, and no wiring is required between the various components of the car park. It includes scanner for ticket and Proximity Card readers

	ESPAS 20-U
Supply voltage	230 VAC ±10%, 50Hz-60Hz
Max power consumption	200 W
Idle power consumption	70 W
Operating temperature	-20 ÷ 50 °C
Sizes	1265 x 341 x 315 mm
Gross weight	60 kg
Standard communication interface	RS485
Standard color	RAL7015
Material	Cabinet in 2,0 mm thick FE360B steel sheet; front panel in anti-wear and anti-scratch polycarbonate,



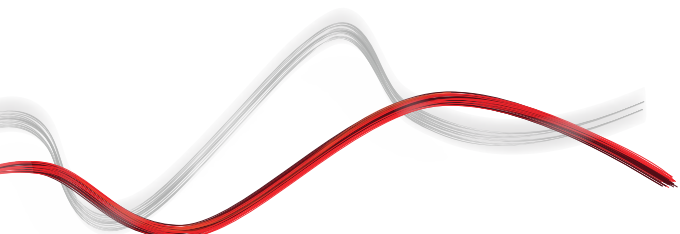











Code	Name	Operator card management	Barrier commands management	Scanner	RFID card reader	Season ticket management	Bus intercom	Motorized ticket reader.
P211E20U11	ESPAS 20-U	●	●	●	●	●		
P211C20U11	ESPAS 20-U CIR	●	●	●	●	●		
P211E20U10	ESPAS 20-U CIT-BUS	●	●	●	●	●	●	
P211E2RU11	ESPAS 20-U PLUS	●	●		●	●		●
P211E2RU10	ESPAS 20-U PLUS CIT-BUS	●	●		●	●	●	●





ESPAS 20

RECOMMENDED ACCESSORIES

	Cp 21261 - Ci 2606001 KIT STATIONS ANCHOR BASE Column anchor base for 20/30 entry/exit terminals		Cp D110945 - Ci 2607227 MAGNETIC LOOP 5MT High sensivity pre-cabled magnetic loop (10m tail x 5m loop)
	Cp D141784 - Ci 2607232 MAGNETIC LOOP 8MT High sensivity pre-cabled magnetic loop (10m tail x 8m loop)		Cp D121711 - Ci 2605801 HEATER UNIT Heater unit 60W for internal station/POF installation on DIN bar
	Cp 385251 - Ci 2604460 TRAFFIC LIGHT 2 LED 100MM Traffic light with two LED lights (red - green) with high brightness for transit regulation. Complete with LED lamps. Diam. 100mm		new Cp P800174 - Ci 2451276 TRAFFIC LIGHT 2 LED 200MM Two LED lights (red/green), high brightness racing-style traffic light system for controlling movements. With LED bulbs. Diameter 200mm.
	Cp 385256 - Ci 2604461 TRAFFIC LIGHT 3 LED 100MM Traffic light with three LED lights (red - red - green) with high brightness for transit regulation. Complete with LED lamps. Diam. 100mm		Cp D413445 - Ci 2605793 TRUCK HEIGHT PEDESTAL 800MM 800mm height pedestal, with door, for entry/exit column
	Cp D413530 - Ci 2605794 BUS HEIGHT PEDESTAL 600MM 600mm height pedestal, with door, for entry/exit column		Cp D113948 - Ci 2605737 LOOP DETECTOR PRO 2 channel loop detector, 24VDC/AC, up to 4 frequencies per channel for close loop installations, adjustable sensitivity, boost function for sensitivity increase. Direction detection.
	Cp D113999 - Ci 2605754 LOOP DETECTOR LITE 2 channel loop detector, 24VDC, up to 4 frequencies per channel for close loop installations, adjustable sensitivity, boost function for sensitivity increase		Cp 394080 - Ci 2607023 PRESENCE AND SAFETY DETECTOR - LASER LOOPS Presence and Safety laser detector. Its used as an alternative of magnetic loops. Includes one input and two relay outputs. Maximum detection range: 9.9m x 9.9m. 10-35VDC power supply.
	Cp 394073 - Ci 2604478 LASER SAFETY SENSOR Safety laser detector. Its used in combination with magnetic loops in order to add an additional safety device (eg: for pedestrian). Includes two relay outputs. Maximum detection range: 5m x 5m. 10-35VDC power supply.		Cp 394075 - Ci 2607020 LASER DETECTOR REMOTE CONTROL Remote control for settings Safety laser detector and Presence and Safety laser detector.
	Cp 394160 - Ci 2604482 PALO ø60 H3600 Galvanized steel pole support for panels and traffic lights. Diam. 60mm - h 3600mm		

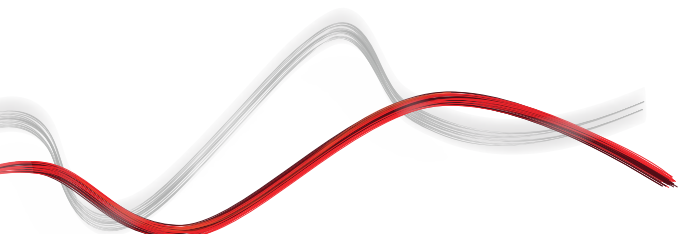



INFORMATION REGARDING THE PROTECTION OF THE INDUSTRIAL AND INTELLECTUAL PROPERTY RIGHTS OF BFT. BFT S.p.A. protects its industrial property by depositing trademarks, patents, models and designs. The intellectual property of BFT S.p.A. is protected by copyright law. BFT S.p.A. also protects its know-how by taking measures to protect the technical and commercial information inherent in its company and products. All the products in this catalogue are ORIGINAL BFT MODELS and only BFT S.p.A. is authorised to produce them and market them anywhere in the world. All the commercial names in this catalogue are owned by BFT S.p.A., and only BFT S.p.A. is authorised to use them in relation to the corresponding merchandise category. FALSIFIERS WILL BE PROCEEDED AGAINST IN ACCORDANCE WITH BOTH CIVIL AND CRIMINAL LAW. THESE CONDITIONS NOT ONLY GUARANTEE THE INTELLECTUAL PROPERTY RIGHTS OF BFT, BUT ALSO PROTECT CUSTOMERS BY GUARANTEEING THAT THE PRODUCTS THEY ARE PURCHASING ARE ORIGINAL BFT PRODUCTS RESULTING FROM STUDIES AND DESIGNS WITHIN THE BFT COMPANY.